



## User's Guide

### Model 6700-C

- Assembly
- Operation
- Maintenance
- Troubleshooting

*Thanks for buying a BISSELL Compact Canister Vacuum.*

We're glad you purchased a BISSELL Butler Revolution™ Compact Canister Vacuum Cleaner. Everything we know about floor care went into the design and construction of this powerful, high-tech home vacuuming system.

Your Butler Revolution™ is well made, and we back it with a comprehensive one-year warranty. We also stand behind it with a knowledgeable, dedicated Customer Service department, so, should you ever have a problem, you'll receive fast, considerate assistance.

My great-grandfather invented the floor sweeper in 1876. Today, BISSELL is a global leader in the design, manufacture, and service of high quality homecare products like your BISSELL Butler Revolution.™

Thanks again, from all of us at BISSELL.

Mark J. Bissell  
President and Chief Executive Officer

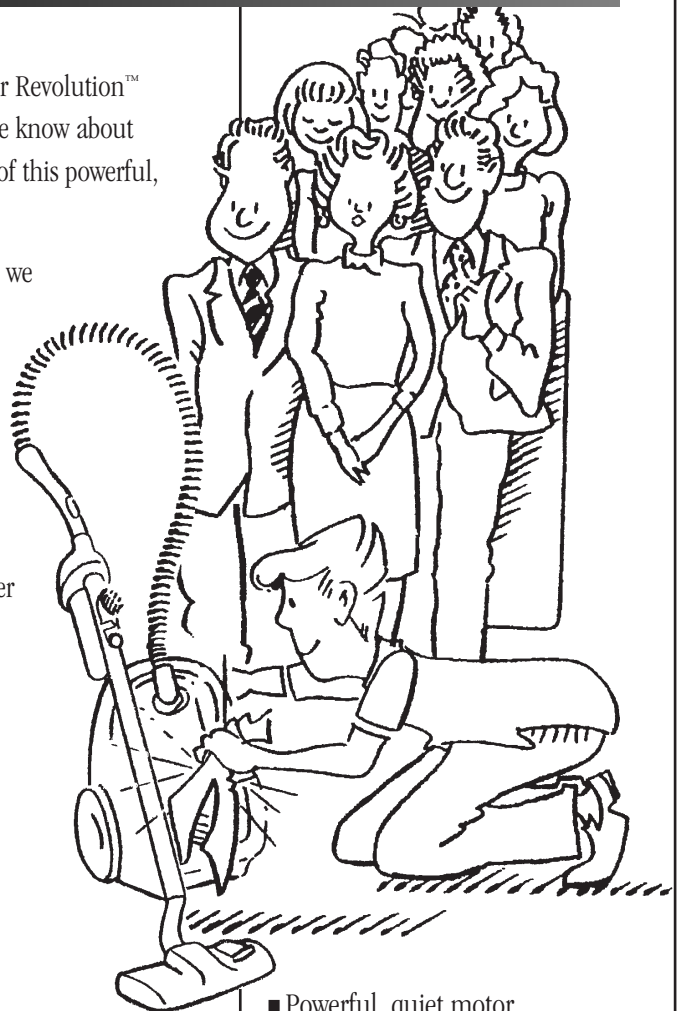

- Powerful, quiet motor
- Multi-surface cleaning capabilities
- Specialized tools for all vacuuming needs
- Long cord with Automatic Rewind feature
- Triple Filtration System

## IMPORTANT SAFETY INSTRUCTIONS

**When using an electrical appliance, basic precautions should be observed, including the following:**

Read all instructions before using your canister vacuum cleaner.

**⚠ WARNING: To reduce the risk of fire, injury or electric shock:**

- Do not leave cleaner when it is plugged in.
- Unplug from outlet when not in use and before servicing.
- Do not use with damaged cord or plug.
- To unplug grasp plug not cord.
- Do not pull or carry by cord, use cord as a handle, close door on cord, pull cord around sharp corners, run cleaner over cord, or expose cord to heated surfaces.
- Hold plug when rewinding the cord onto the reel. Do not allow the plug to whip when rewinding.
- Do not use cleaner if it has been dropped, damaged, left outdoors or dropped into water. Return it to an Authorized Service Centre.
- Do not allow children to use as a toy.
- Do not use outdoors or on wet surfaces.
- Do not handle cleaner or plug with wet hands.
- Do not put any object into openings, use with blocked opening, or restrict air flow.
- Do not use without dust bag and/or filters in place.
- Do not allow hair, loose clothing, fingers or body parts to get near openings or floor brush in the appliance.
- Do not pick up hot coals, cigarette butts, matches or any hot, smoking, or burning objects.
- Do not pick up hard or sharp objects such as glass, nails, screws, coins, etc.
- Do not pick up flammable or combustible materials (lighter fluid, gasoline, kerosene, etc.) or use in the presence of explosive liquids or vapour.
- Do not pick up toxic material (chlorine bleach, ammonia, drain cleaner, etc.).
- Do not use in an enclosed space filled with vapours given off by oil base paint, paint thinner, some moth proofing substances, flammable dust, or other explosive or toxic vapours.
- Do not use for any purpose other than described in this User's Guide.
- Always turn off this appliance before connecting or disconnecting vacuum hose.
- Use only manufacturer's recommended attachments.
- Use only on dry, indoor surfaces.
- Keep openings free of dust, lint, hair, etc.
- Keep appliance on a level surface.
- Turn off all controls before plugging or unplugging cleaner.
- Be extra careful when cleaning stairs.
- Pay close attention when working around children.

## SAVE THESE INSTRUCTIONS

### THIS APPLIANCE HAS A POLARIZED PLUG.

To reduce the risk of electric shock, this appliance has a polarized plug (one blade is wider than the other). This plug will fit in a polarized outlet only one way. If the plug does not fit fully in the outlet, reverse the plug. If it still does not fit, contact a qualified electrician to install a proper outlet. Do not change the plug in any way.

This model is for household use only.

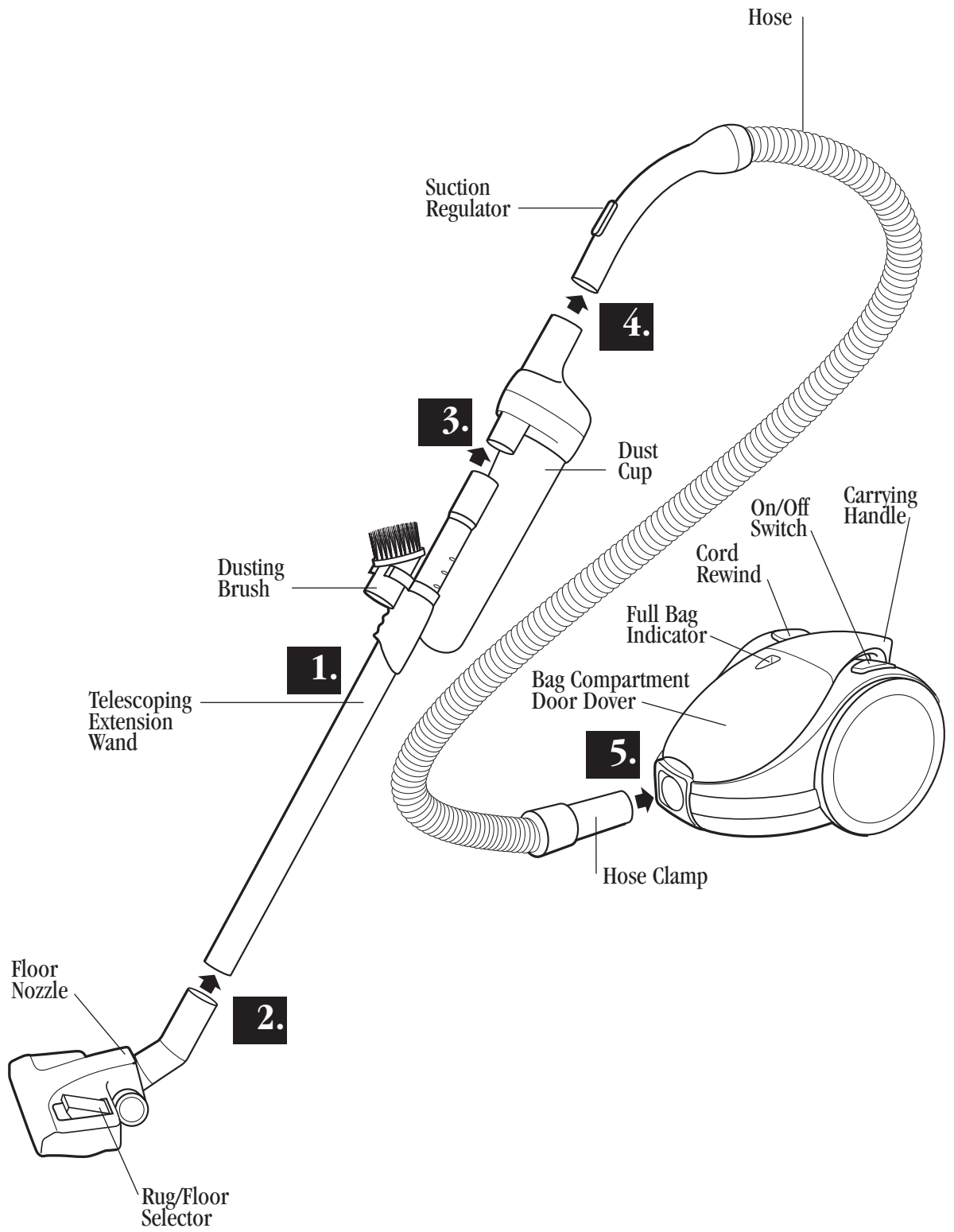

## How to use this guide

This User's Guide has been designed to help you get the utmost satisfaction from your BISSELL® Butler Revolution. You'll find assembly and operating instructions, safety precautions, as well as maintenance and troubleshooting instructions. Please read this Guide thoroughly before assembling your cleaner.

Pay particular attention to the assembly diagram, assembly instructions, and part names. Locate and organize all parts before assembly. Familiarize yourself with the parts and where they go. Following this User's Guide will greatly enhance your ability to get the most performance from your BISSELL® Butler Revolution for many years.

## How to put it together

### Assembling the Vacuum Cleaner for Use

- 1.** Pick up the Extension Wand. Place one hand on the black plastic grip. Place the other hand on the expanded end. Pull to extend.
- 2.** Slide the narrow end of the Extension Wand into the Floor Nozzle Tube.
- 3.** Slide the narrow end of the Dust Cup bracket into the expanded end of the Extension Wand.
- 4.** Slide the handle end of the Hose into the large end of the Dust Cup bracket.
- 5.** Slide the Hose Clamp into the suction inlet of the unit.

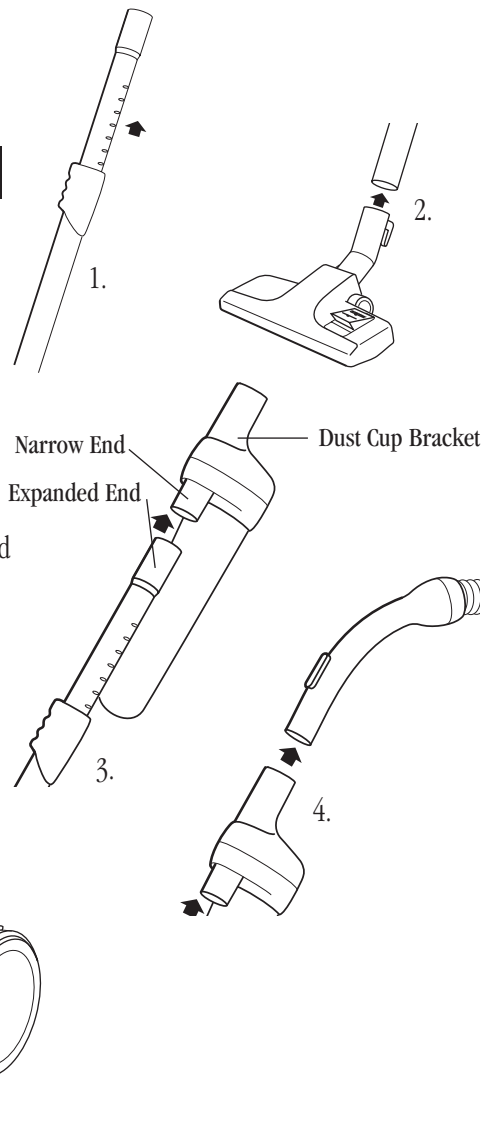

## Index

Safety instructions	.....2
Product view	.....3
How to put it together	.....4
Index	.....5
Using special tools	.....5
Operating/Maintenance	...6-7
Troubleshooting	.....8
Replacement parts	.....9
Warranty	.....10
Customer Service	.....10

## Special tools

### Rug/Floor Selector

Before use, make sure that the position of the select button is in the right position for the type of surface to be cleaned.

Push the side 1 when cleaning the carpets.

Push the side 2 when cleaning the floor, tile, mat, etc.

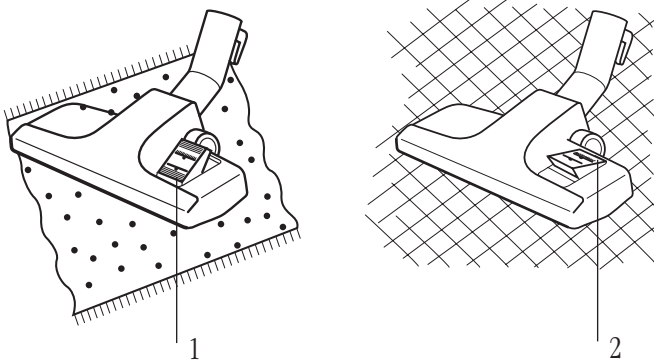

### Dusting Brush

To use the Dusting Brush, remove the handle end of the Hose from the top of the Dust Cup Bracket. Attach Dusting Brush to hose end.

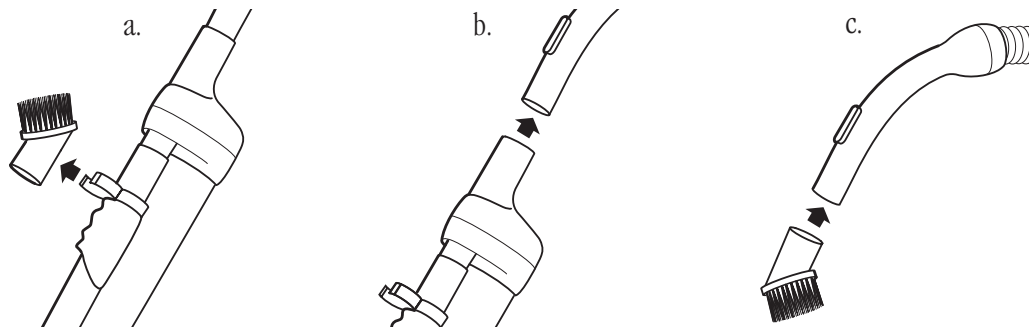

# Operating/Maintenance Instructions for your BISSELL Compact Canister Vacuum Cleaner

**WARNING:** Hold plug when rewinding the cord onto the reel. Do not allow the cord to whip when rewinding.

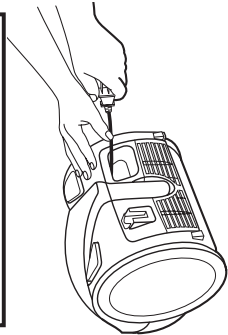

## Cord Storage

To extend the Power Cord for use, grasp the plug and gently pull out from the vacuum cleaner. When removing the Power Cord from the electrical outlet, switch off the power and grasp the plug. Your cleaner is equipped with an automatic rewind button. When cleaning is finished, switch off power and disconnect the plug from the electrical outlet, then press on the Cord Rewind Button with your hand. The Cord will be rewound automatically.

## Full Bag Indicator

You may continue cleaning until the Full Bag Indicator changes into the red colour. This means the dust bag is full and needs to be replaced. If the indicator suddenly works and the cleaner loses suction power while in use, turn your cleaner off and check whether the hose, pipe or nozzle is clogged.

## Dust Bag Replacement

**NOTE:** Hose must be disconnected before changing bag. Replace the dust bag as soon as it is full.

1. To open the Dust Bag Compartment Door, lift the cover upward.
2. Remove the dust bag from the cleaner.
3. Dispose of the full bag and insert the cardboard bag collar of the dust bag as far as it can go on the suction inlet, and press down the locker. Position the dust bag so that no part of the bag is pinched.
4. The Pre-motor inlet Filter is changed by sliding the Filter Bracket upward, and sliding the Filter out/in.
5. Press the front of the Dust Bag Compartment Door down lightly until it re-locks.
6. The Post Motor Filter is changed by sliding the holder down and removing/replacing the Filter.

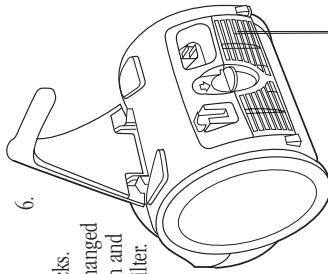
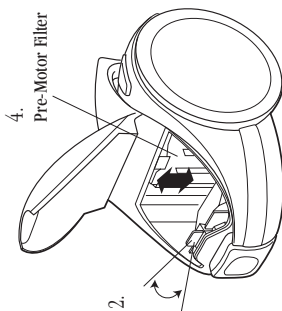
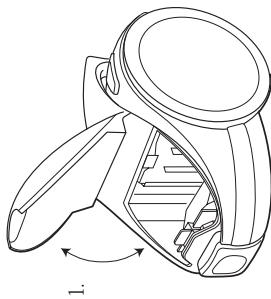

Post-Motor Filter

## Storage

Your cleaner is designed to stand firmly upright for cleaning and storage. Use in this manner and it takes up a minimum of space, and allows you to work in the narrowest spaces.

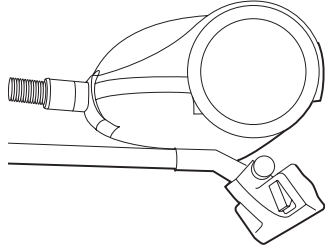

## Tool Storage

Your cleaner features a tool storage space. It can be used to store the cleaning tool while it is not in use.

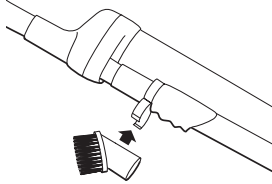

## Dust Cup

Your cleaner features a Dust Cup for cleaning and emptying convenience. When cup is full, remove and empty as shown.

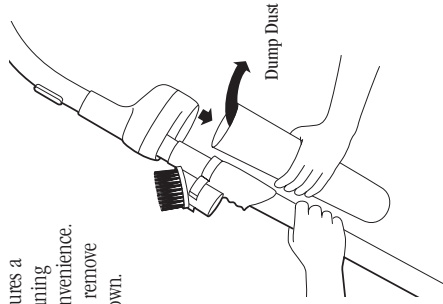

## Troubleshooting

This appliance was inspected thoroughly and was in good operating condition when it was shipped from the factory. If a minor problem occurs, it usually can be solved quite easily when the cause is found. Therefore, this check list is provided for your convenience.



**WARNING:** To reduce the risk of injury from moving parts and/ or electrical shock, turn Power Switch OFF and disconnect polarized plug from electrical outlet before performing troubleshooting checks.

### ***Vacuum cleaner won't run.***

#### Possible Causes

Vacuum cleaner is not fully plugged in  
No voltage in wall plug

#### Remedies

Plug in fully and turn switch to ON position  
Check fuse or breaker

### ***Vacuum cleaner won't pick up dirt.***

#### Possible Causes

Dust Bag is full  
Hose, Wands, Dust Cup or Floor Nozzle clogged with a large object

#### Remedies

Change Dust Bag  
Remove substance

# Replacement parts

Item	Part No.	Part Name
1	603-2020	Dusting Brush
2	603-2017	Floor Nozzle
3	603-2018	Hose
4	603-2015	Telescoping Extension Wand
5	603-2019	Tool Clip
6	603-2016	Dust Cup

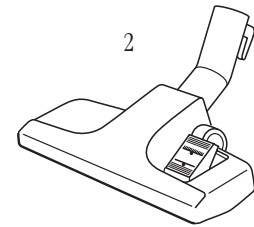
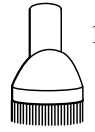

If suggested solutions for this or any function of the cleaner do not correct the problem, call:

**BISSELL Customer Service**

**1-800-263-2535**

Monday - Friday

8:00 A.M. - 4:30 P.M. (E.S.T.)

Or visit our Web Site @ [www.bissell.com](http://www.bissell.com)

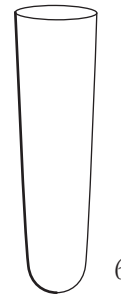
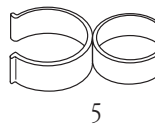
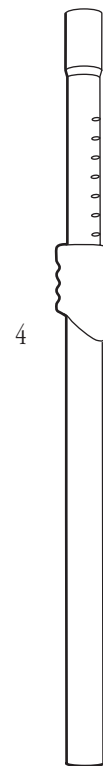
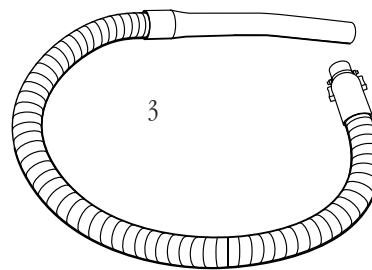

Please have your model and part numbers of unit ready.



## About your warranty

### One Year Warranty

BISSELL Ltd., or an authorized BISSELL Service Centre will repair or replace, free of charge, any part which is defective or malfunctioning within 1 year of the purchase date, provided that it is used for personal, and not commercial or rental service.

### Terms:

1. Return the unit and/or part with proof of purchase date, to your dealer, your nearest BISSELL Authorized Service Centre, or return by mail to:

BISSELL Ltd.  
6934 Kinsmen Court,  
Niagara Falls, Ontario, L2E 6S5

2. Any defective or malfunctioning part will be repaired or replaced and returned postage paid.
3. This warranty does not cover bags, belts, filters or light bulbs. Damages or malfunctions caused by negligence, abuse, or use not in accordance with the User's Guide will not be covered. This warranty does not cover parts of the unit that require replacement under normal use.

For your protection, you should always insure the unit and/or part when shipping or mailing. BISSELL will reimburse you for the parcel post, CanPar or UPS charge. Any charges for packaging or insurance are your responsibility.

Tip: Attach your sales receipt to this user's Guide for future reference.

## BISSELL Customer Service

If you need information about repairs or replacement parts, or questions about your warranty, call:

**BISSELL Customer Service**

**1-800-263-2535**

Monday - Friday 8 A.M. - 4:30 P.M. (E.S.T.)

Or write:

**BISSELL Ltd.**

**ATTN: Customer Service**

**Box 1003**

**Niagara Falls, Ont., L2E 6W2**

When contacting BISSELL, have model number of unit available.

Please record your Model Number: \_\_\_\_\_

Please record your Purchase Date: \_\_\_\_\_

**Note: Please keep your original sales receipt. It is your warranty. It is suggested you staple your original receipt to the front of this guide.**



©2000 BISSELL Inc.

BISSELL Ltd.

Niagara Falls, Ont. L2E 6W2

All rights reserved. Printed in Korea

Part Number 603-5846

Visit our Web Site at: [www.bissell.com](http://www.bissell.com)